



ULN2804

LINEAR INTEGRATED CIRCUIT

EIGHT HIGH VOLTAGE, HIGH CURRENT DARLINGTON ARRAYS

DESCRIPTION

The **ULN2804** is a high voltage, high current Darlington array comprised of eight NPN Darlington pairs. The device features open-collector outputs with suppression diodes for inductive loads and is ideally suited for interfacing between low-level logic circuitry and high power loads. Typical loads including relays DC motors, filament lamps, LED displays, printer hammers and high power buffers.

FEATURE

- * Eight Darlington pairs with common emitters
- * TTL, PMOS or CMOS Compatible inputs
- * Peak output current to 500mA
- * Output voltage to 50V
- * Clamp diodes for transient suppression
- * DIP-28 and SOP-18 packages

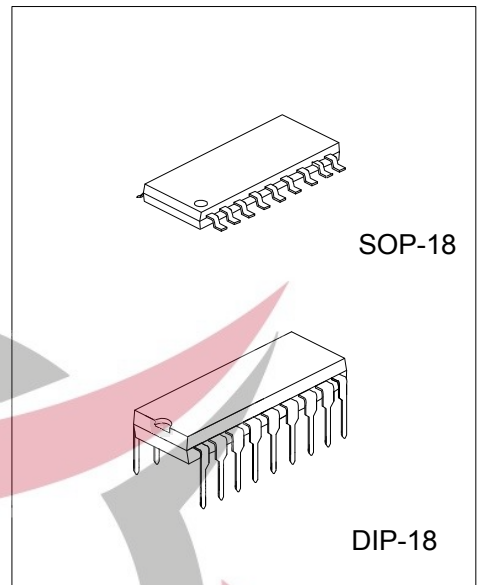

ORDERING INFORMATION

Order Number	Package	Packing
ULN2804G-D18-T	DIP-18	Tube
ULN2804G-S18-R	SOP-18	Tape Reel
ULN2804G-S18-T	SOP-18	Tube

ULN2804G-D18-T	(1) Packing Type (2) Package Type (3) Green Package	(1) R: Tape Reel, T: Tube (2) D18: DIP-18, S18: SOP-18 (3) G: Halogen Free and Lead Free
----------------	---	--

MARKING

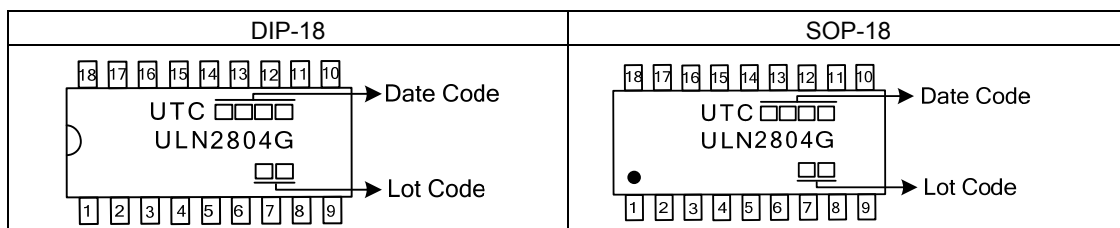

■ PIN CONFIGURATIONS

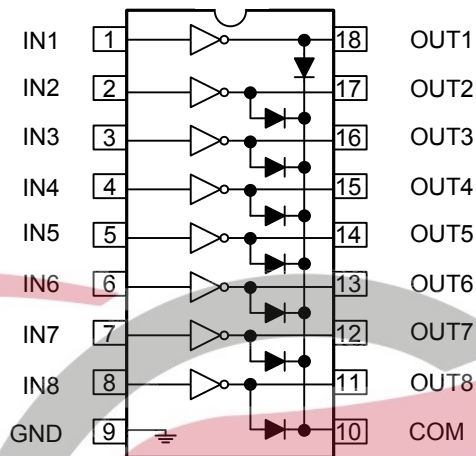

■ SCHEMATICS

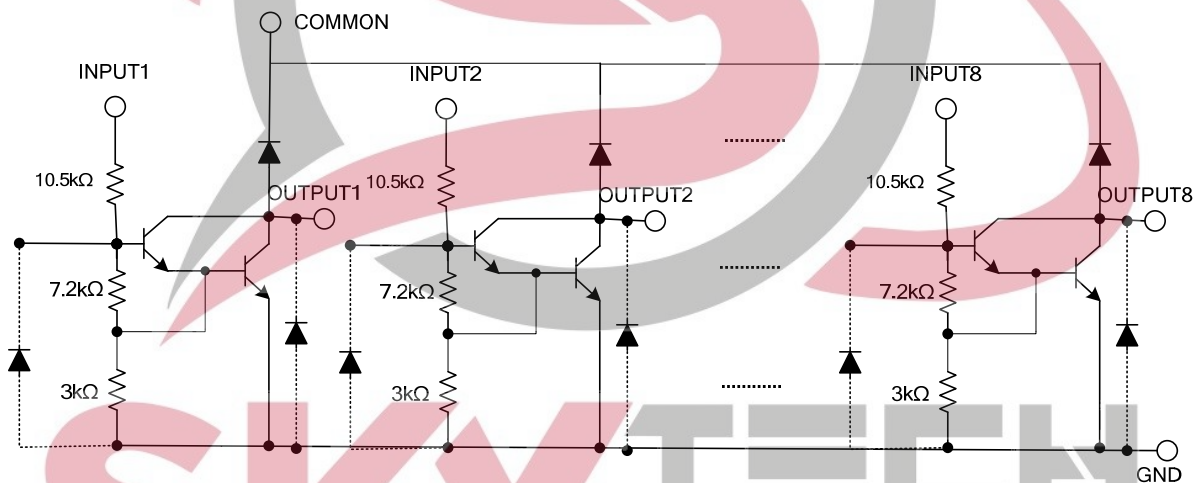

■ ABSOLUTE MAXIMUM RATINGS

PARAMETER		SYMBOL	RATINGS	UNIT
Input Voltage		V_{IN}	30	V
Output Voltage		V_{OUT}	50	V
Collector Current – Continuous		I_C	500	mA
Base Current – Continuous		I_B	25	mA
Power Dissipation	DIP-18	P_D	1.5	W
	SOP-18		0.95	W
Junction Temperature		T_J	+120	°C
Operating Ambient Temperature		T_{OPR}	0 ~ +70	°C
Storage Temperature		T_{STG}	-55 ~ +150	°C

Note Absolute maximum ratings are those values beyond which the device could be permanently damaged.

Absolute maximum ratings are stress ratings only and functional device operation is not implied

■ THERMAL DATA

PARAMETER		SYMBOL	RATING	UNIT
Thermal resistance from junction to Ambient	DIP-18	θ_{JA}	60	°C /W
	SOP-18		80	°C /W

■ ELECTRICAL CHARACTERISTICS (Ta = 25°C, unless otherwise specified.)

PARAMETER		SYMBOL	TEST FIGURE	TEST CONDITIONS	MIN	TYP	MAX	UNIT	
Collector-Emitter Saturation Voltage		$V_{CE(SAT)}$	1	$I_{OUT}=350mA, I_{IN}=500\mu A$		1.3	1.6	V	
				$I_{OUT}=200mA, I_{IN}=350\mu A$		1.1	1.3	V	
				$I_{OUT}=100mA, I_{IN}=250\mu A$		0.9	1.1	V	
Input Voltage		$V_{IN(ON)}$	2	$V_{CE}=2.0V$			5.0	V	
					$I_{OUT}=125mA$			6.0	V
					$I_{OUT}=200mA$			7.0	V
					$I_{OUT}=350mA$			8.0	V
Clamp Diode Forward Voltage		V_F	3	$I_F=350mA$		1.5	2.0	V	
Output Leakage Current		I_{CEX}	4a	$V_{OUT}=50V, Ta=70^\circ C$			100	μA	
			4b	$V_{OUT}=50V, Ta=70^\circ C, V_{IN}=1.0V$			500		
Input Current	ON	$I_{IN(ON)}$	5	$V_{IN}=5V$		0.35	0.5	mA	
	OFF	$I_{IN(OFF)}$	6	$V_{IN}=12V$		1.0	1.45	mA	
Clamp Diode Reverse Current		I_R	7	$V_R=50V, Ta=25^\circ C$			50	μA	
				$V_R=50V, Ta=70^\circ C$			100	μA	
DC Current Gain		h_{FE}		$V_{OUT}=2V, I_{OUT}=350mA$	1000				
Input Capacitance		C_{IN}				15	25	pF	
Turn-On Delay		t_{ON}	8			0.25	1	μS	
Turn-Off Delay		t_{OFF}	8			0.25	1	μS	

TEST FIGURES

Figure 1.

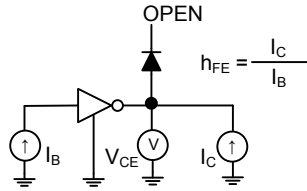

Figure 2.

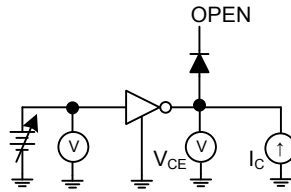

Figure 3.

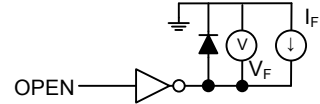

Figure 4a.

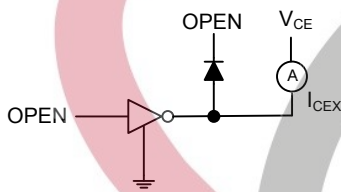

Figure 4b.

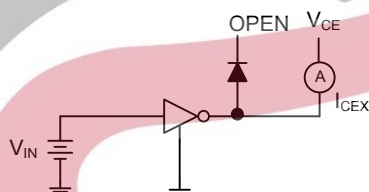

Figure 5.

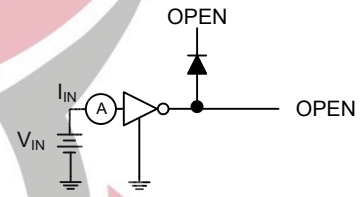

Figure 6.

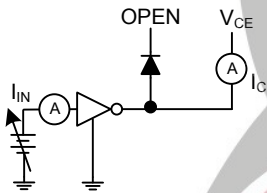

Figure 7.

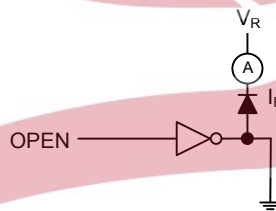
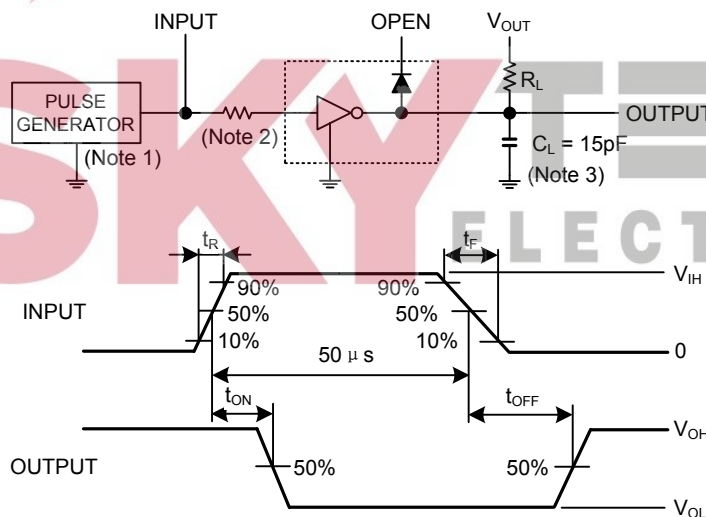
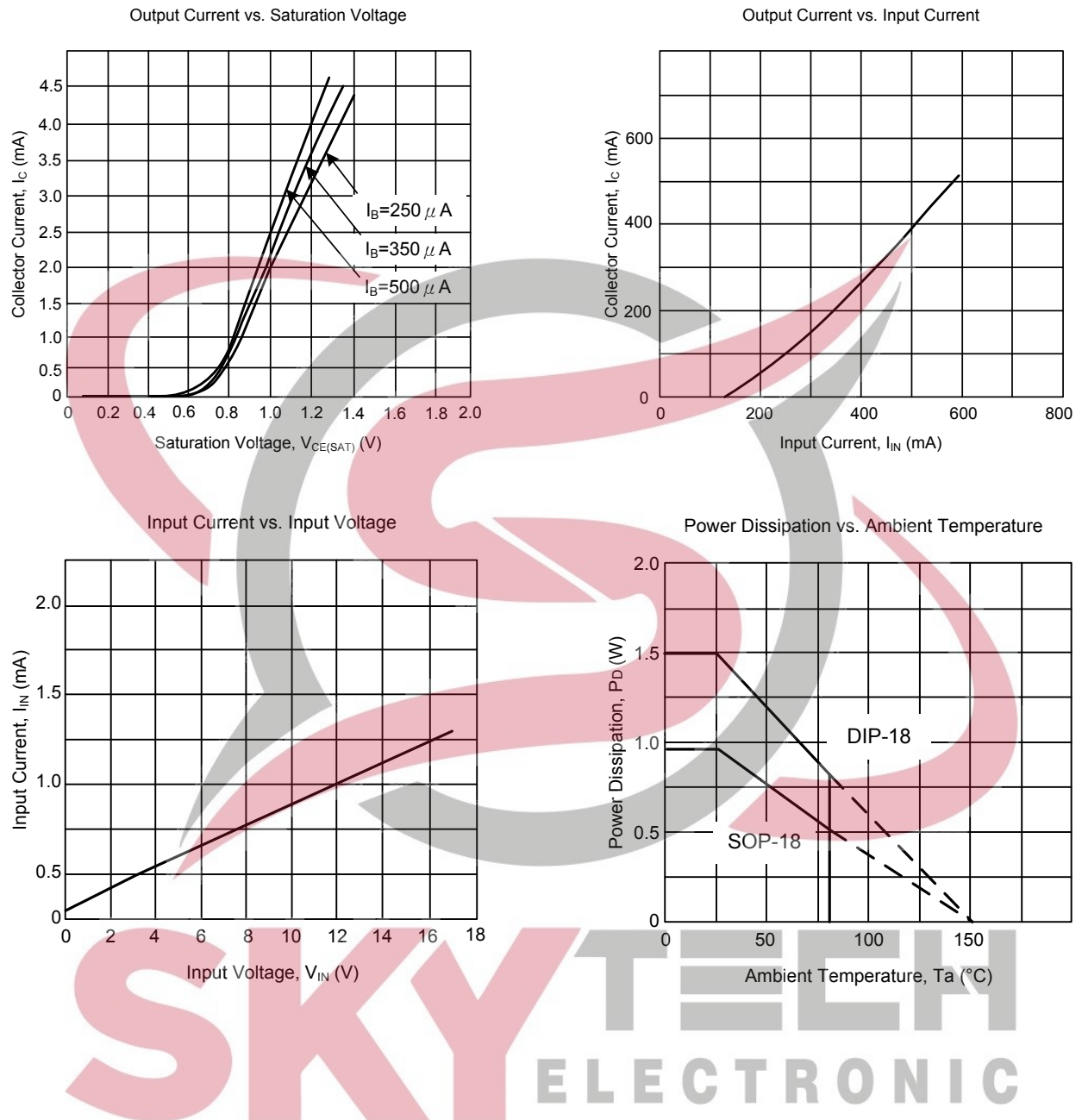

Figure 8.



- Note1: Pulse width 50µs, duty cycle 10%
Output impedance 50Ω, $t_R \leq 5\text{ns}$, $t_F \leq 10\text{ns}$
- Note2: $R1 = 0$, $V_{IH} = 3\text{V}$
- Note3: C_L includes probe and jig capacitance.

TYPICAL CHARACTERISTICS



UTC assumes no responsibility for equipment failures that result from using products at values that exceed, even momentarily, rated values (such as maximum ratings, operating condition ranges, or other parameters) listed in products specifications of any and all UTC products described or contained herein. UTC products are not designed for use in life support appliances, devices or systems where malfunction of these products can be reasonably expected to result in personal injury. Reproduction in whole or in part is prohibited without the prior written consent of the copyright owner. The information presented in this document does not form part of any quotation or contract, is believed to be accurate and reliable and may be changed without notice.